

SA52-11EWA/GWA/YWA/SRWA

SC52-11EWA/GWA/YWA/SRWA

Features

- 0.52 INCH DIGIT HEIGHT.
- LOW CURRENT OPERATION.
- EXCELLENT CHARACTER APPEARANCE.
- EASY MOUNTING ON P.C. BOARDS OR SOCKETS.
- I.C. COMPATIBLE.
- CATEGORIZED FOR LUMINOUS INTENSITY, YELLOW AND GREEN CATEGORIZED FOR COLOR.
- MECHANICALLY RUGGED.
- STANDARD : GRAY FACE, WHITE SEGMENT.

Description

The High Efficiency Red source color devices are made with Gallium Arsenide Phosphide on Gallium Phosphide Orange Light Emitting Diode.

The Green source color devices are made with Gallium Phosphide Green Light Emitting Diode.

The Yellow source color devices are made with Gallium Arsenide Phosphide on Gallium Phosphide Yellow Light Emitting Diode.

The Super Bright Red source color devices are made with Gallium Aluminum Arsenide Red Light Emitting Diode.

Package Dimensions & Internal Circuit Diagram

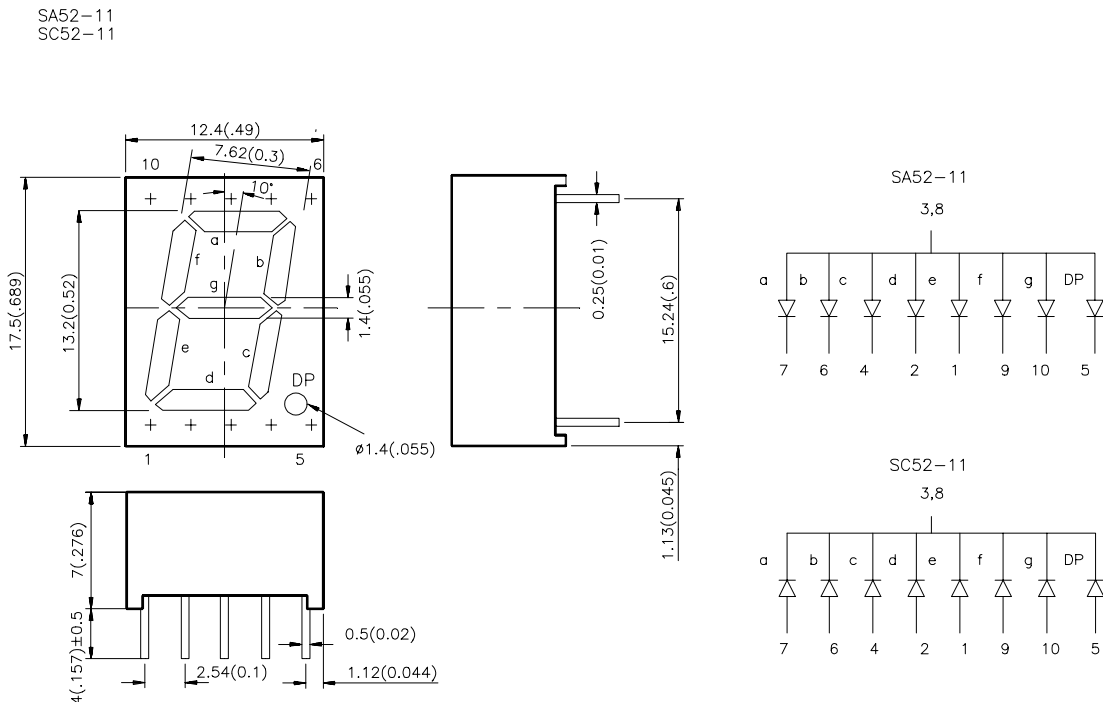

Notes:

1. All dimensions are in millimeters (inches), Tolerance is $\pm 0.25(0.01)$ unless otherwise noted.
2. Specifications are subject to change without notice.

Selection Guide

Part No.	Dice	Iv (ucd) @ 10 mA		Description
		Min.	Typ.	
SA52-11EWA	HIGH EFFICIENCY RED (GaAsP/GaP)	1900	6400	Common Anode, Rt. Hand Decimal
SC52-11EWA				Common Cathode, Rt. Hand Decimal
SA52-11GWA	GREEN (GaP)	3000	10500	Common Anode, Rt. Hand Decimal
SC52-11GWA				Common Cathode, Rt. Hand Decimal
SA52-11YWA	YELLOW (GaAsP/GaP)	1900	4700	Common Anode, Rt. Hand Decimal
SC52-11YWA				Common Cathode, Rt. Hand Decimal
SA52-11SRWA	SUPER BRIGHT RED (GaAlAs)	8000	24000	Common Anode, Rt. Hand Decimal
SC52-11SRWA				Common Cathode, Rt. Hand Decimal

Electrical / Optical Characteristics at T_A=25°C

Symbol	Parameter	Device	Typ.	Max.	Units	Test Conditions
λ_{peak}	Peak Wavelength	High Efficiency Red Green Yellow Super Bright Red	627 565 590 660		nm	IF=20mA
λ_D	Dominate Wavelength	High Efficiency Red Green Yellow Super Bright Red	625 568 588 640		nm	IF=20mA
$\Delta\lambda_{1/2}$	Spectral Line Halfwidth	High Efficiency Red Green Yellow Super Bright Red	45 30 35 20		nm	IF=20mA
C	Capacitance	High Efficiency Red Green Yellow Super Bright Red	15 15 20 45		pF	VF=0V;f=1MHz
V _F	Forward Voltage	High Efficiency Red Green Yellow Super Bright Red	2.0 2.2 2.1 1.85	2.5 2.5 2.5 2.5	V	IF=20mA
I _R	Reverse Current	All		10	uA	VR = 5V

Absolute Maximum Ratings at $T_A=25^\circ\text{C}$

Parameter	High Efficiency Red	Green	Yellow	Super Bright Red	Units
Power dissipation	105	105	105	100	mW
DC Forward Current	30	25	30	30	mA
Peak Forward Current [1]	160	140	140	155	mA
Reverse Voltage	5	5	5	5	V
Operating/Storage Temperature	-40°C To +85°C				
Lead Solder Temperature [2]	260°C For 5 Seconds				

Notes:

- 1/10 Duty Cycle, 0.1ms Pulse Width.
- 4mm below package base.

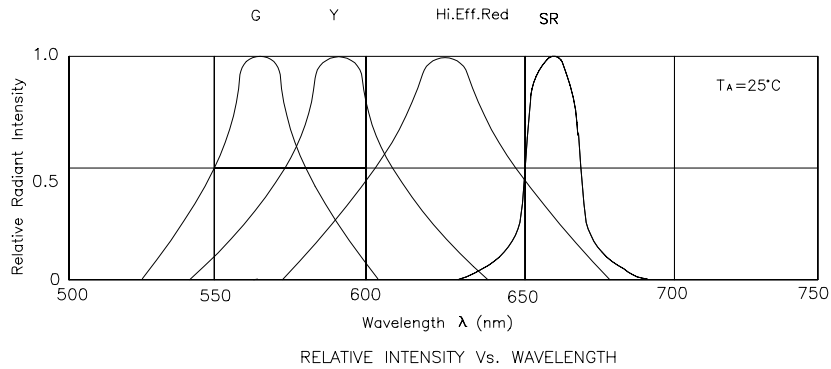

High Efficiency Red

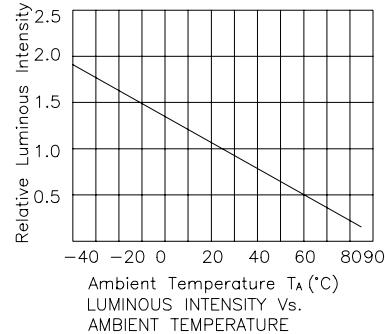
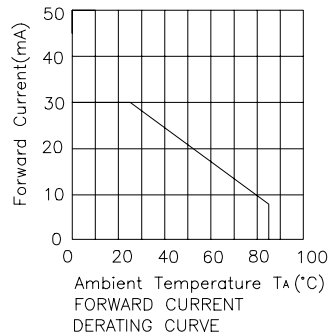
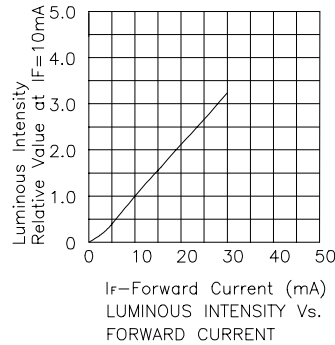
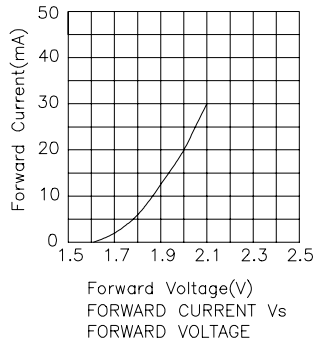

Green

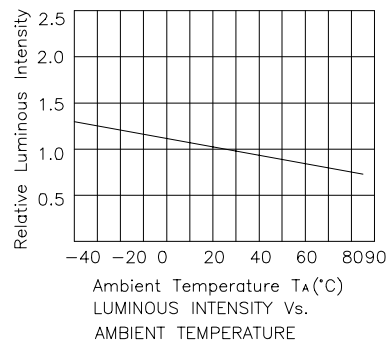
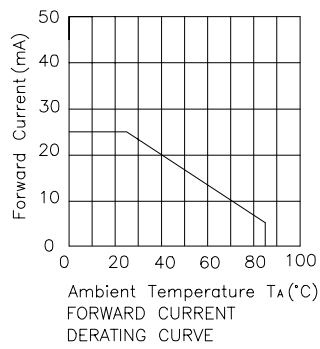
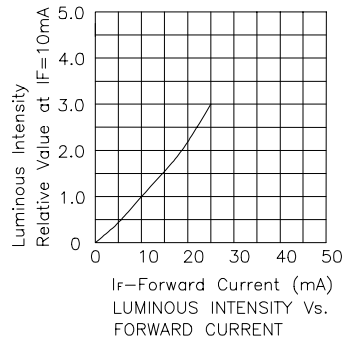
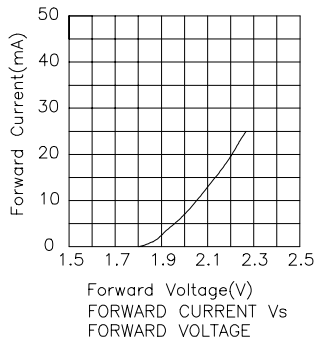

Yellow

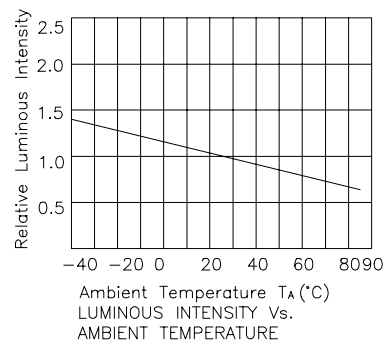
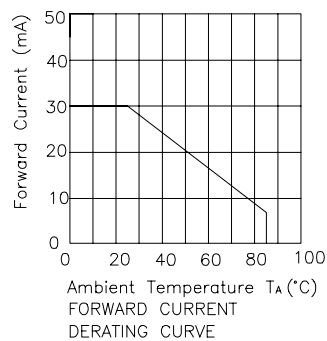
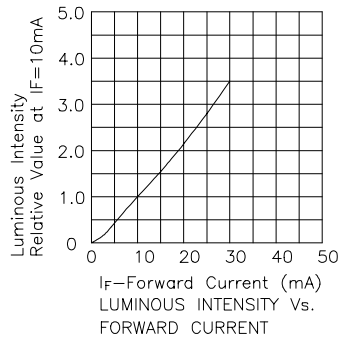
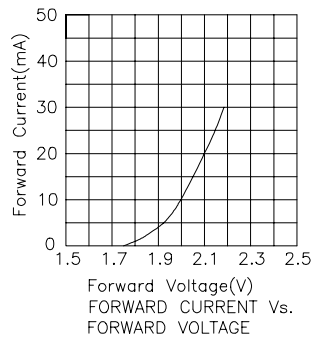

Super Bright Red

